

LOC	DIST	REVISIONS			
ES	00	REV	DATE	BY	APPD
		B	20DEC2007	SL	SY
		B1	04JUN08	AZ	SY

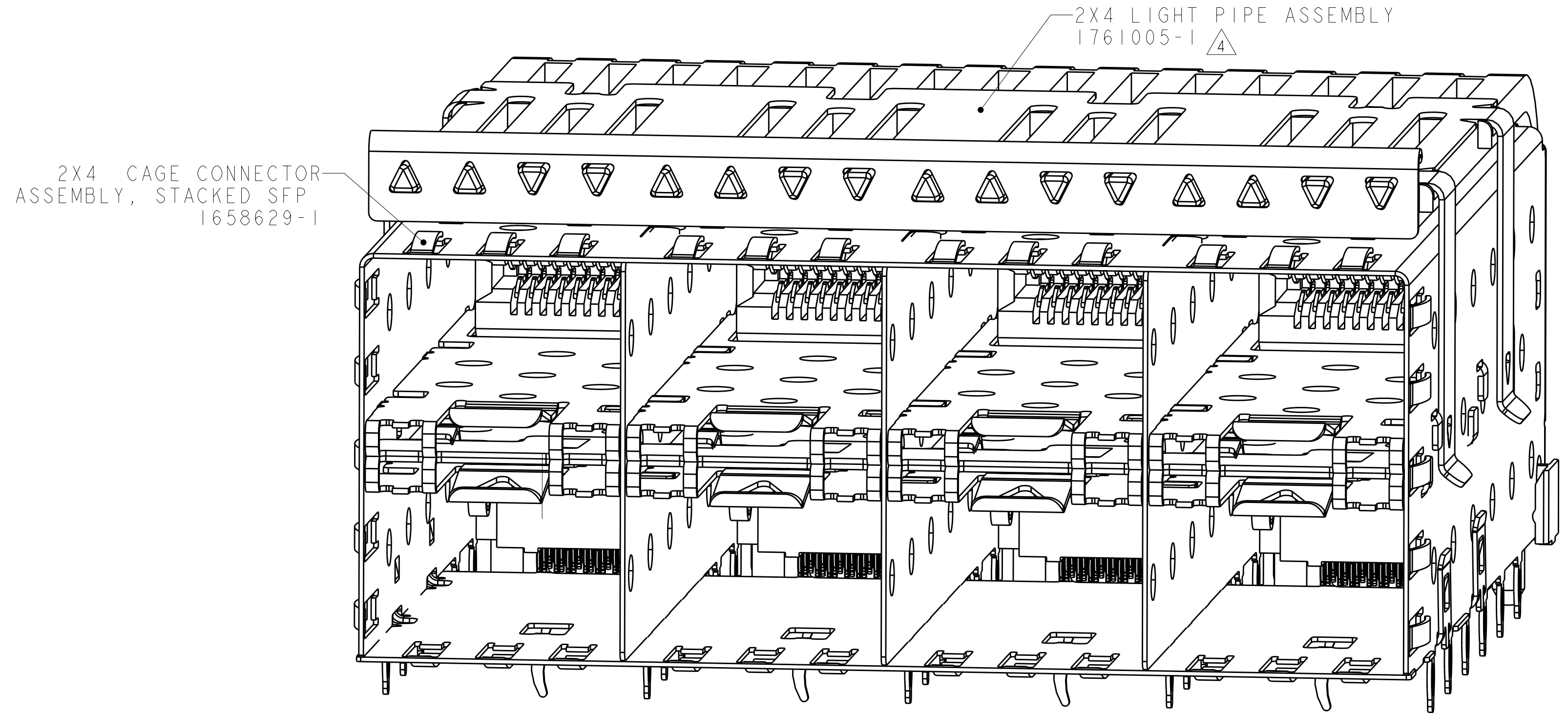
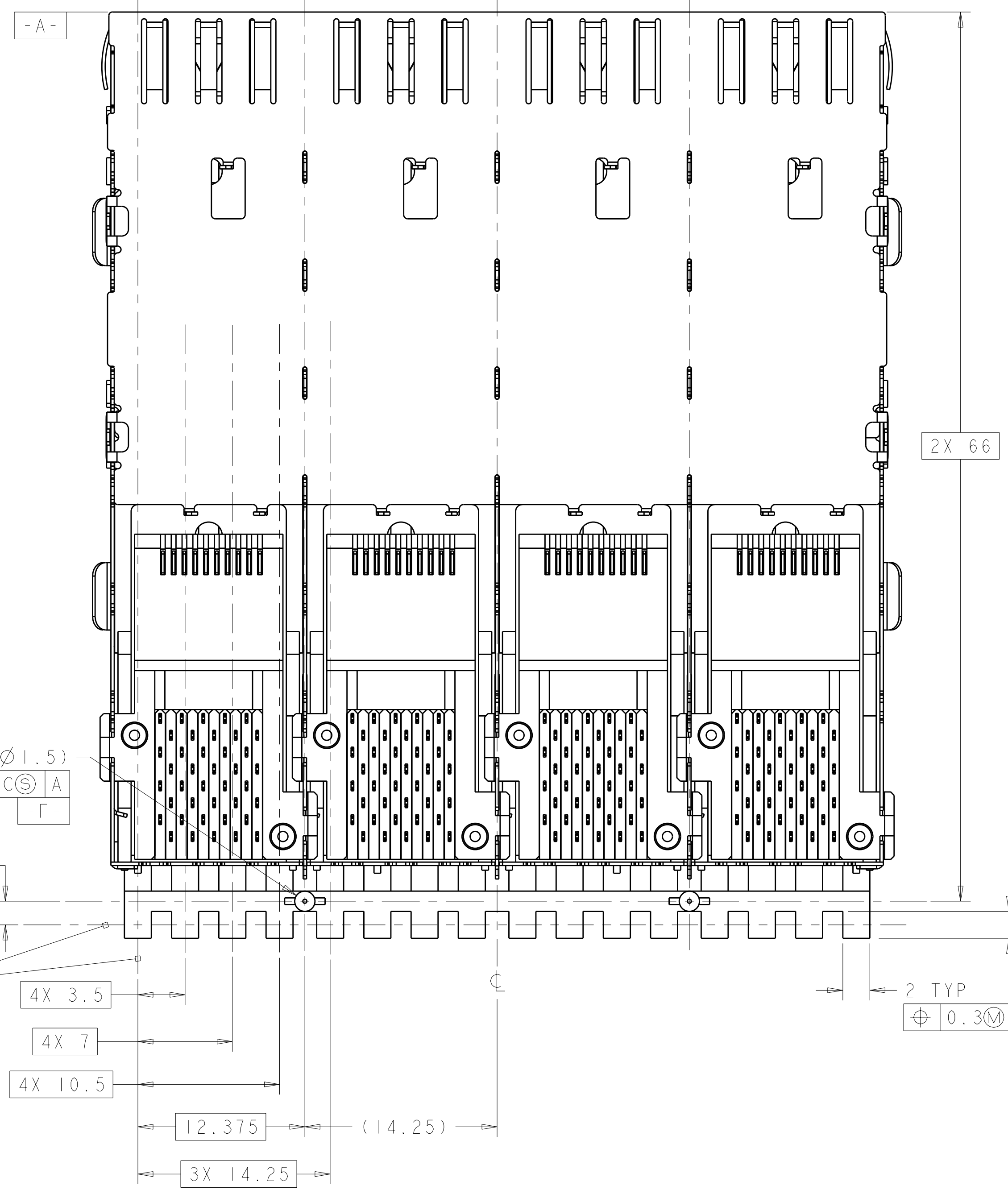
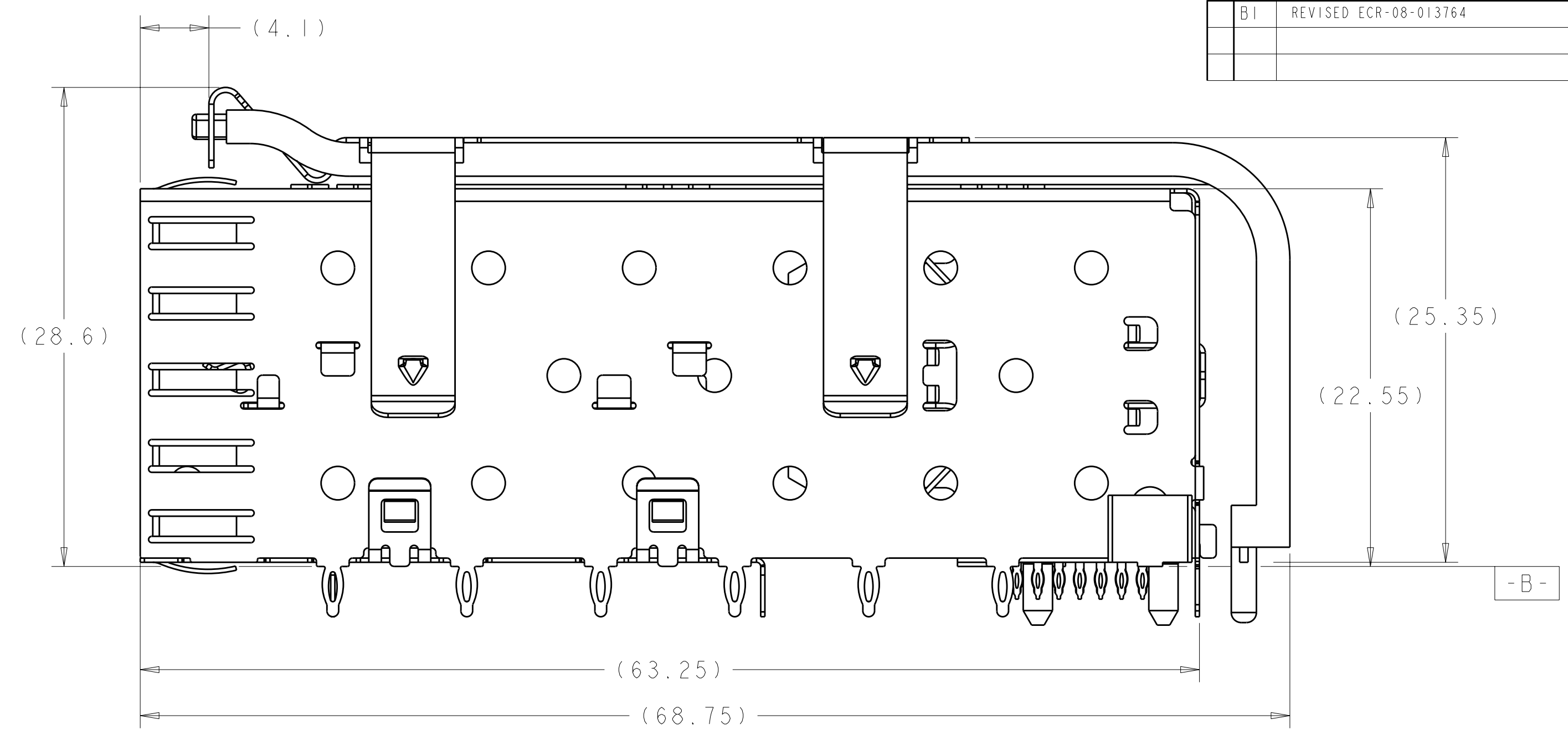
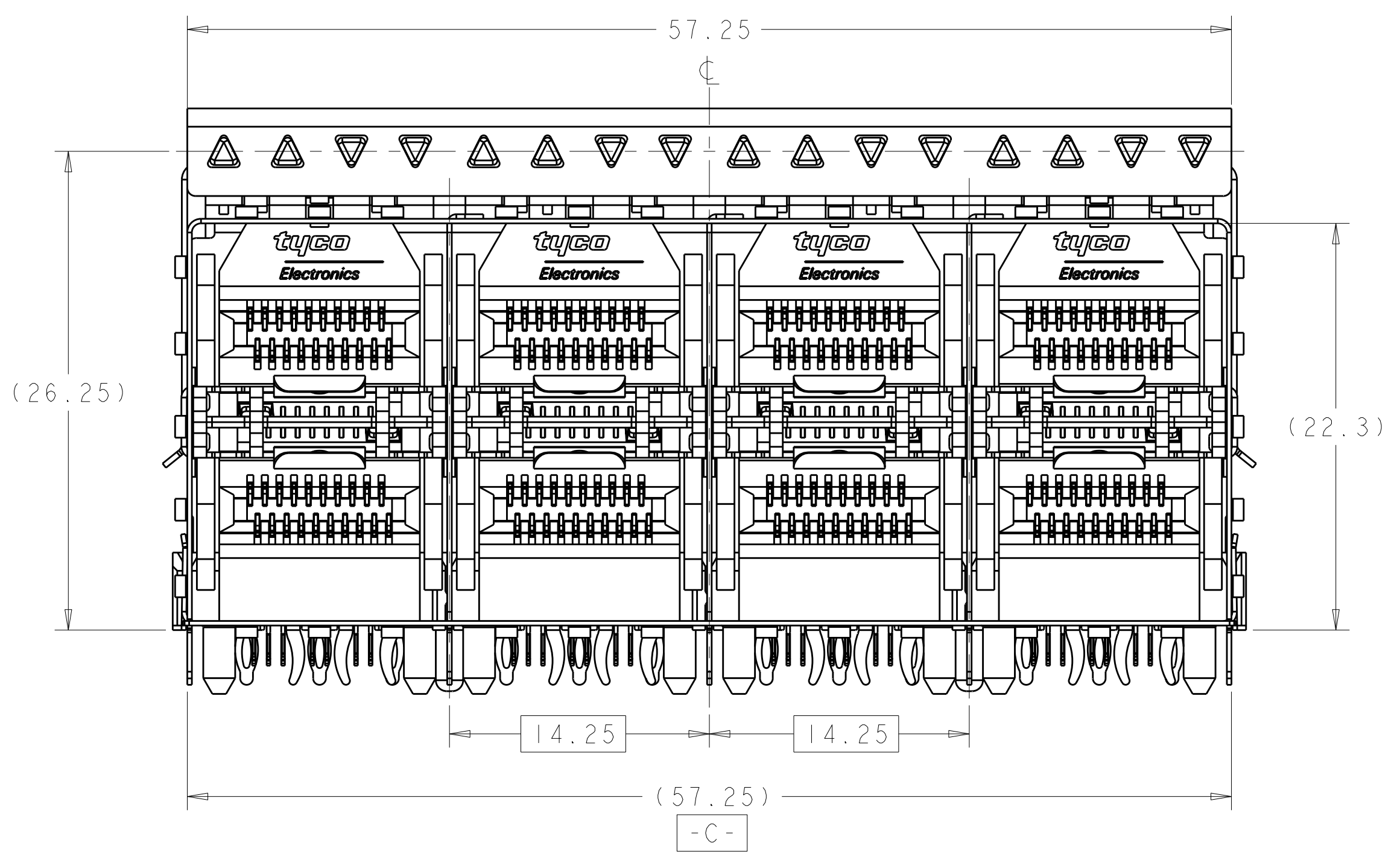

- 1. DATUM AND BASIC DIMENSION TO BE DETERMINED BY CUSTOMER
- 2. DATUM C APPLIES OVER ENTIRE DIMENSION
- 3. INTERPRETATION OF DATUM REFERENCE FRAME IN ACCORDANCE WITH SECT 4.4.1.1 OF ASME Y14.5M-1994
- 4. LIGHT PIPE KIT SUPPLIED SEPERATELY, KIT TO BE ATTACHED AFTER SEATING OF 1658629-1 ON BOARD.
- 5. CONNECTOR ASSEMBLY CONSIST OF LIGHT PIPE ASSEMBLY AND CAGE/CONNECTOR ASSEMBLY, SUPPLIED UNASSEMBLED.
- 6. LABEL ON CAGE ASSEMBLY WILL HAVE PART NUMBER 1658629-1.

1658758-1
PART NUMBER

<small>THIS DRAWING IS UNPUBLISHED. RELEASED FOR PUBLICATION 2006 BY TYCO ELECTRONICS CORPORATION. ALL RIGHTS RESERVED.</small>		DWN: M.E. COWHER CHK: R.R. HENRY APVD: R.R. HENRY DATE: 18JUN2003 NAME: 2X4 CONNECTOR ASSEMBLY, STACKED SFP, WITH 2X4 SFP CAGE AND LIGHT PIPE KIT	Tyco Electronics Shanghai, China
DIMENSIONS: mm TOLERANCES UNLESS OTHERWISE SPECIFIED: 9 PLC ±0.25 1 PLC ±0.25 3 PLC ±0.1 4 PLC ± ANGLES ±	MATERIAL: - FINISH: -	PRODUCT SPEC: 108-2161 APPLICATION SPEC: 114-13103 WEIGHT: - SCALE: 4:1	SHEET 1 OF 2 REV B1

LOC		DIST		REVISIONS			
ES	00	P	LTR	DESCRIPTION	DATE	DWN	APVD
				SEE SHEET 1			

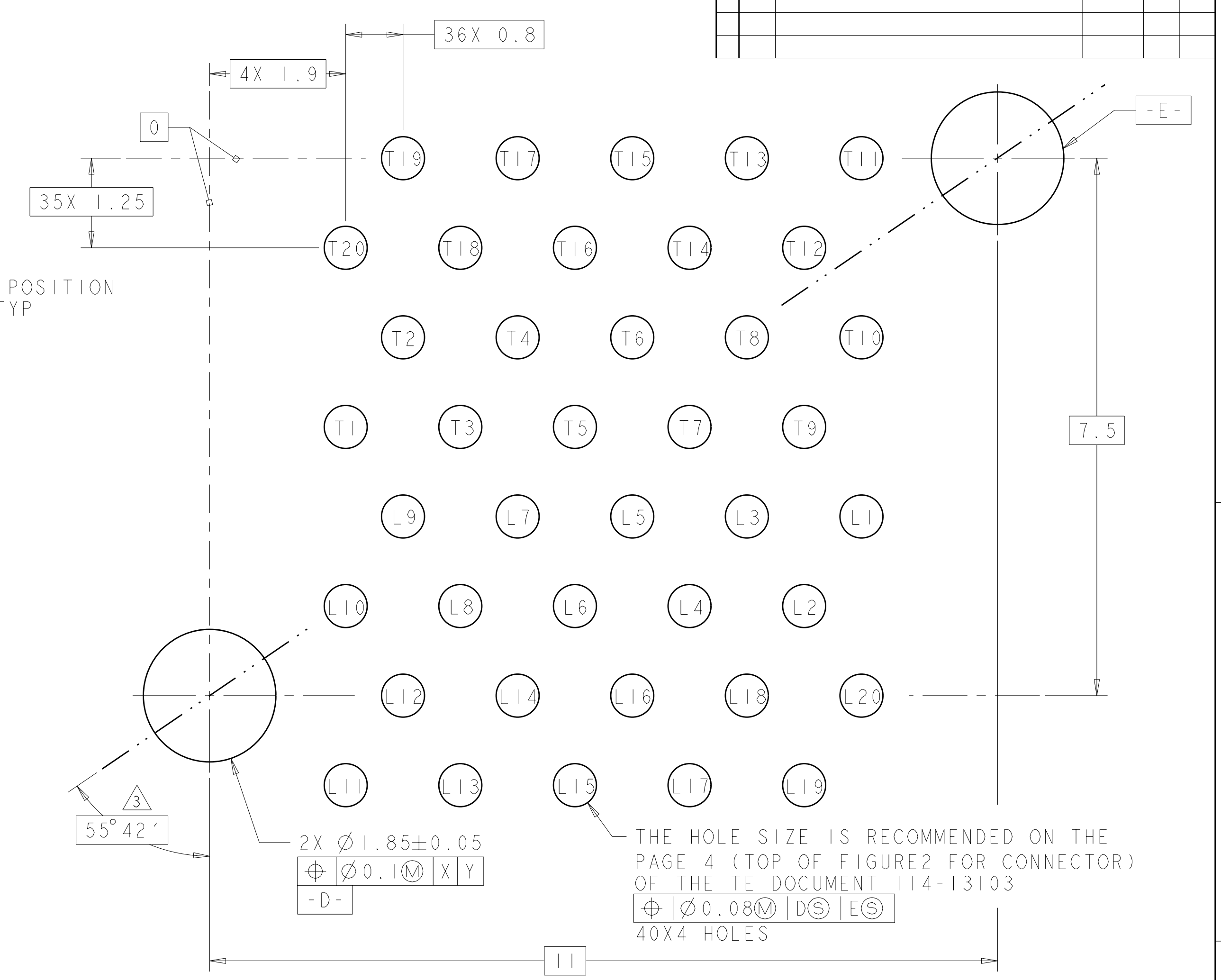
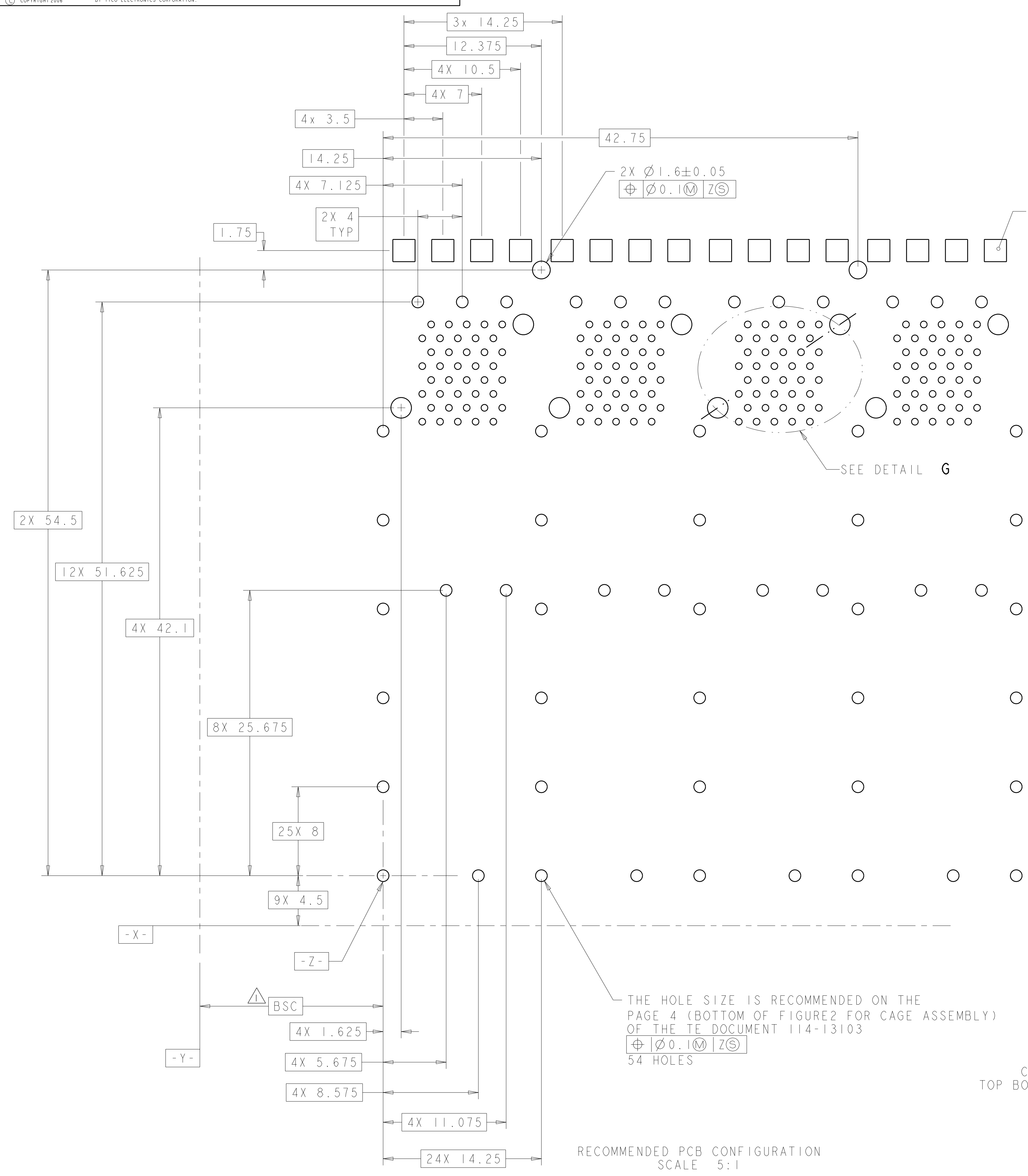

DETAIL G
 RECOMMENDED PT CONNECTOR CONFIGURATION
 4X INDIVIDUALLY
 SCALE 20:1

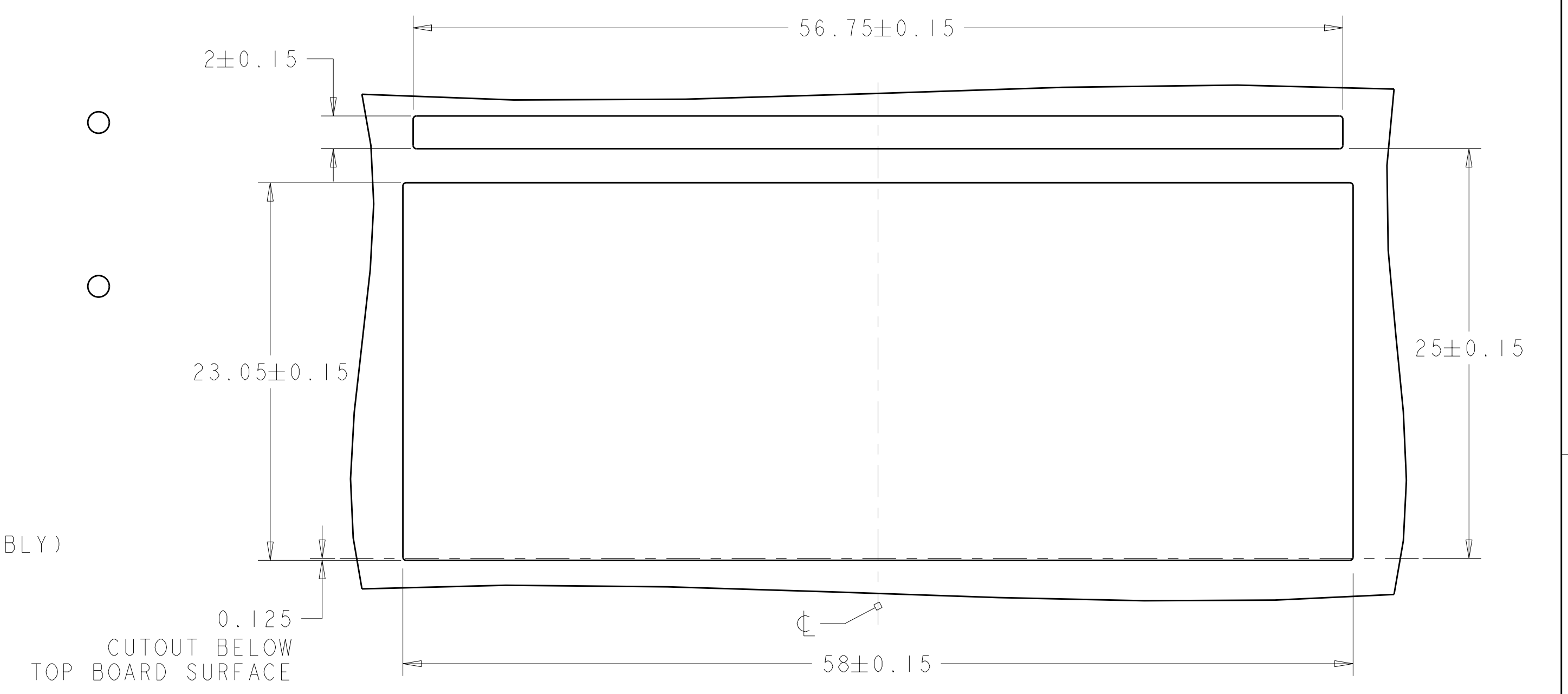

RECOMMENDED BEZEL CUTOUT
 SCALE 4:1

THE HOLE SIZE IS RECOMMENDED ON THE PAGE 4 (BOTTOM OF FIGURE 2 FOR CAGE ASSEMBLY) OF THE TE DOCUMENT 114-13103
 Ø 0.1 (M) Z(S)
 54 HOLES

DIMENSIONS:		TOLERANCES UNLESS OTHERWISE SPECIFIED:		DWN M. E. COWHER 18JUN2003		Tyco Electronics Tyco Electronics Shanghai, China	
mm	9 PLC ±0.25	1 PLC ±0.25	5 PLC ±0.1	CHK R. R. HENRY 18JUN2003	NAME R. R. HENRY 18JUN2003	2X4 CONNECTOR ASSEMBLY, STACKED SFP, WITH 2X4 SFP CAGE AND LIGHT PIPE KIT	
	4 PLC ±	ANGLES ±	FINISH ±	PRODUCT SPEC 108-2161	APPLICATION SPEC 114-13103	SIZE CAGE CODE DRAWING NO	RESTRICTED TO
MATERIAL				WEIGHT	114-13103	A 00779 C=1658758	
				CUSTOMER DRAWING		SCALE 4:1	SHEET 2 OF 2